

66054 PATENTE
ROMPE VISTA
Longitud: 6,10 m

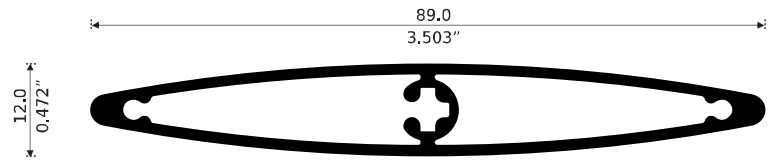

6054
ROMPE VISTA
Longitud: 6,10 m

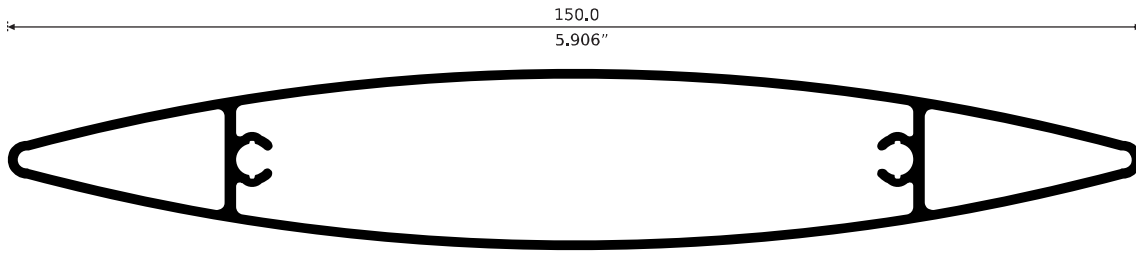

66055
ROMPE VISTA
Longitud: 6,10 m

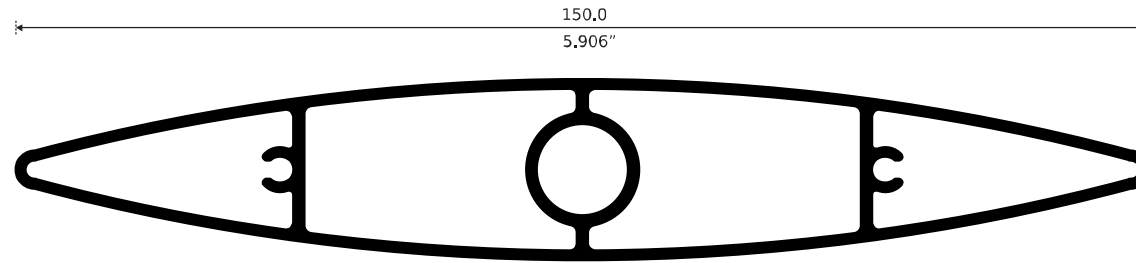

6055
ROMPE VISTA
Longitud: 6.10 m

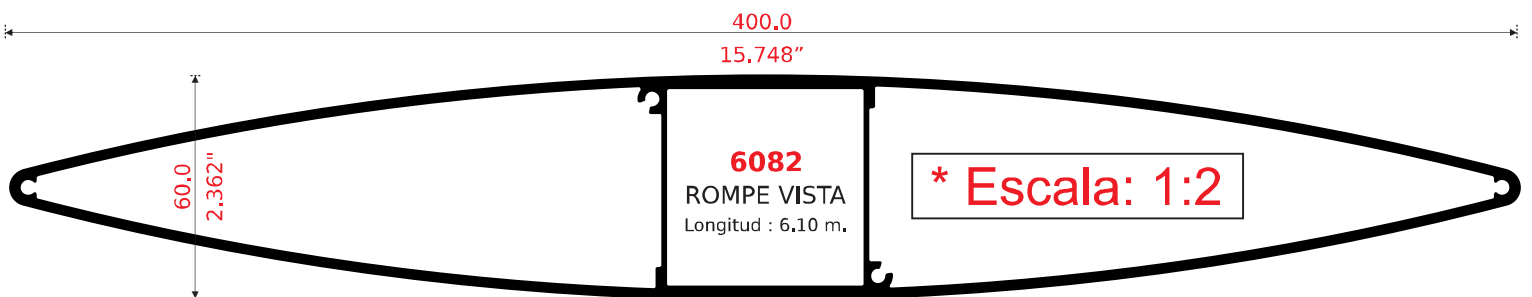

6082
ROMPE VISTA
Longitud : 6,10 m,

*** Escala: 1:2**

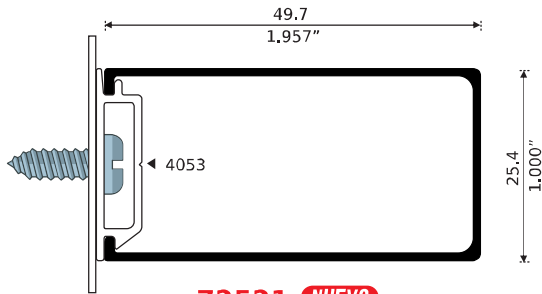
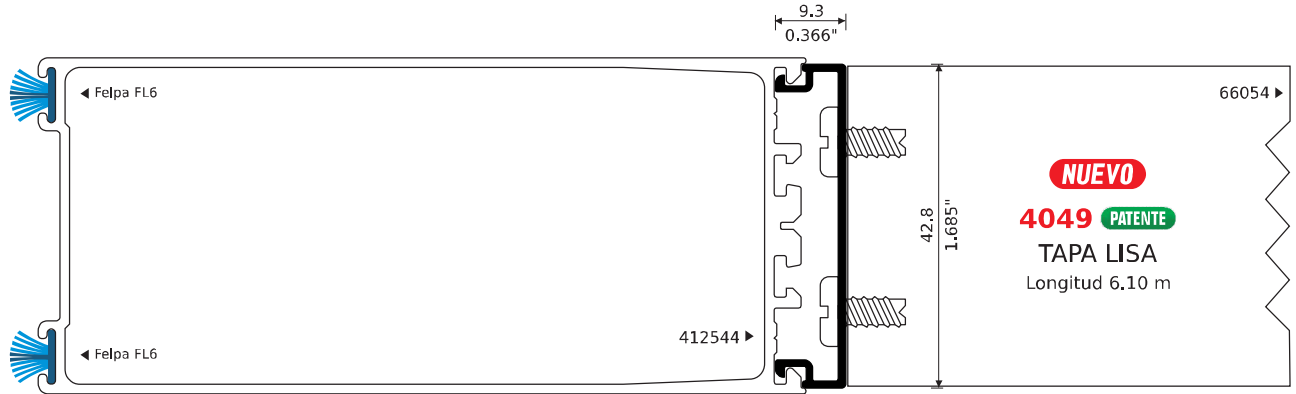

72521 NUEVO
ROMPE VISTA
Longitud: 6.10 m

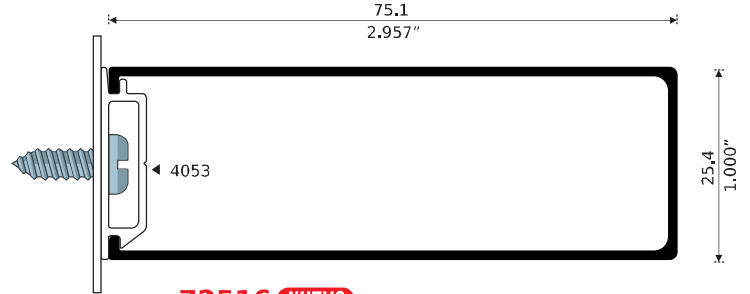

72516 NUEVO
ROMPE VISTA
Longitud: 6.10 m

VISTA ELEGANTE

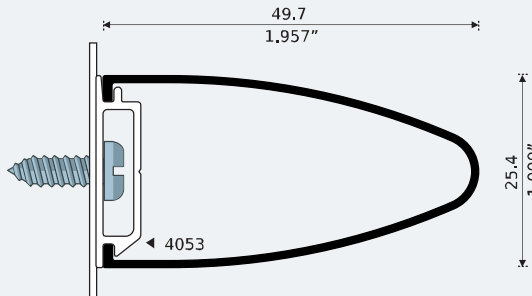

82521 NUEVO
ROMPE VISTA
Longitud: 6.10 m

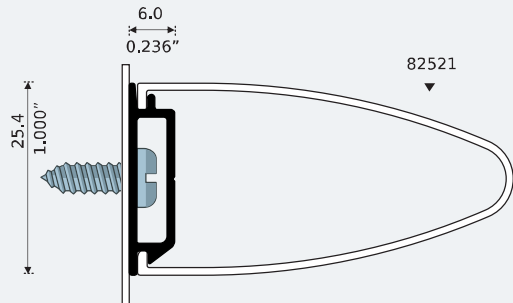

4053 NUEVO
TAPA ROMPE VISTA
Longitud: 6.10 m

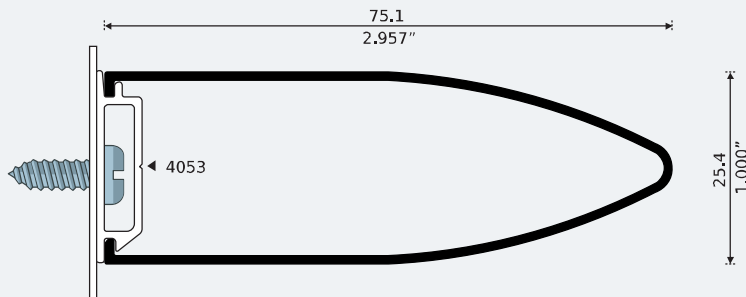

82516 NUEVO
ROMPE VISTA
Longitud: 6.10 m

Esta Línea se arma con: **Pija 10 x 1 1/2"**

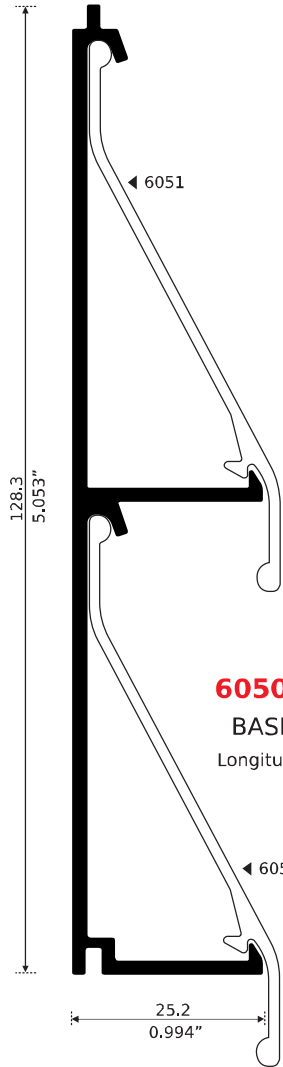

6051 **PATENTE**
CLIP
Longitud: 6.10 m

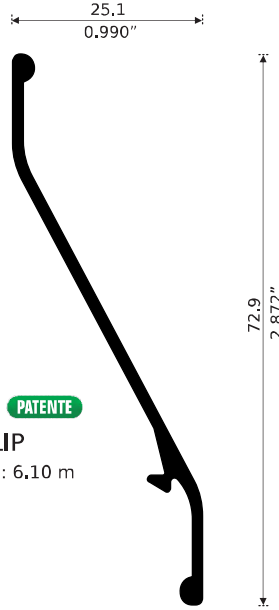

6053
CELOSIA FIJA
Longitud: 6.10 m

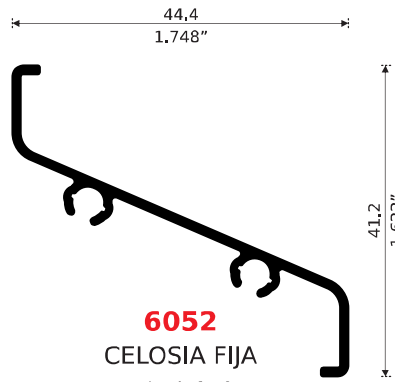
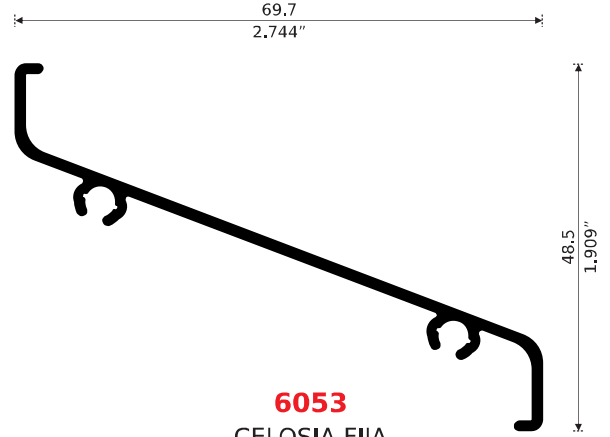

6052
CELOSIA FIJA
Longitud: 6.10 m

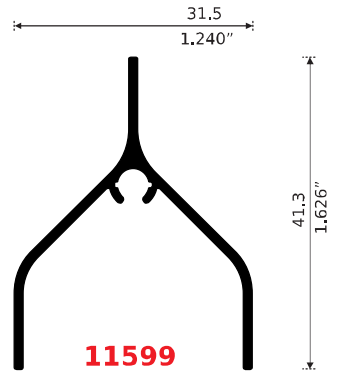

11599
CELOSIA FIJA
DOBLE VISTA
Longitud: 6.10 m



Celosia 6053

Celosia 6052

Celosia 11599